

Varenummer: 03551110

Beskrivelse: Fluro hydraulik ledhoved FPR 110CE

Mål

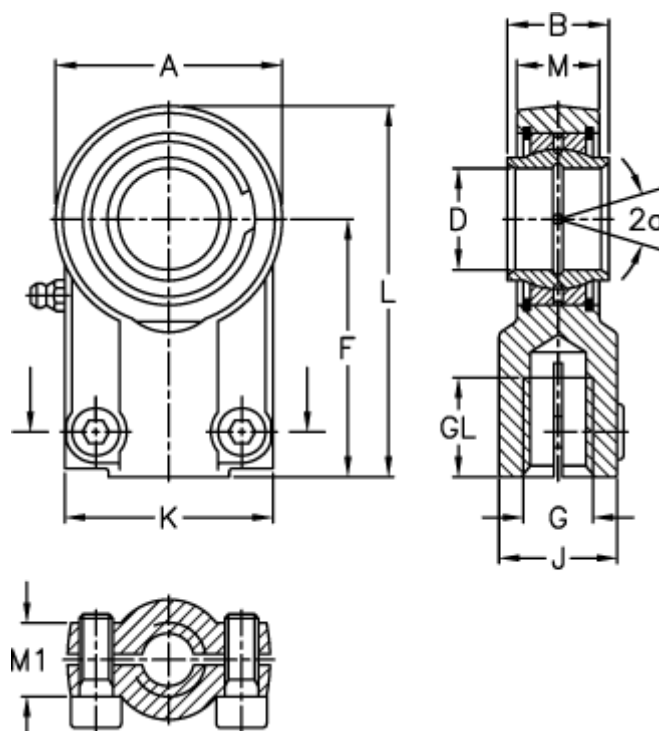

A	= 235	J	= 125
a (grader)	= 4	K	= 190
B	= 110	L	= 364
D	= 110	M	= 88
Dynamisk belastning C (kN)	= 655	M1	= 62
F	= 235	Moment (Nm)	= 710
g	= M90x3	Statisk belastning C0 (kN)	= 1200
GL	= 106	Vægt	= 32000